



INTERVENTIONAL  
VASCULAR  
DIAGNOSTICS AND  
THERAPY

# CARDIOLOGY

YOUR PARTNER FOR CORONARY ANGIOPLASTY

# B. BRAUN VASCULAR SYSTEMS

THE EUROPEAN ALTERNATIVE FOR COMPETENT SERVICES AND HIGH QUALITY PRODUCTS

B. Braun SE is one of the world's leading providers and manufacturers of healthcare solutions with a tradition going back more than 180 years.

The company offers products and services for vascular interventions, anesthesiology, intensive care medicine, infusion therapy, surgery and medical engineering. By offering supplementary services and consulting, B. Braun serves hospitals and doctors as a system partner.

Through constructive dialogues with partners and customers, more than 62,000 B. Braun employees are dedicated to developing effective solutions and contributing to medical advancement worldwide.

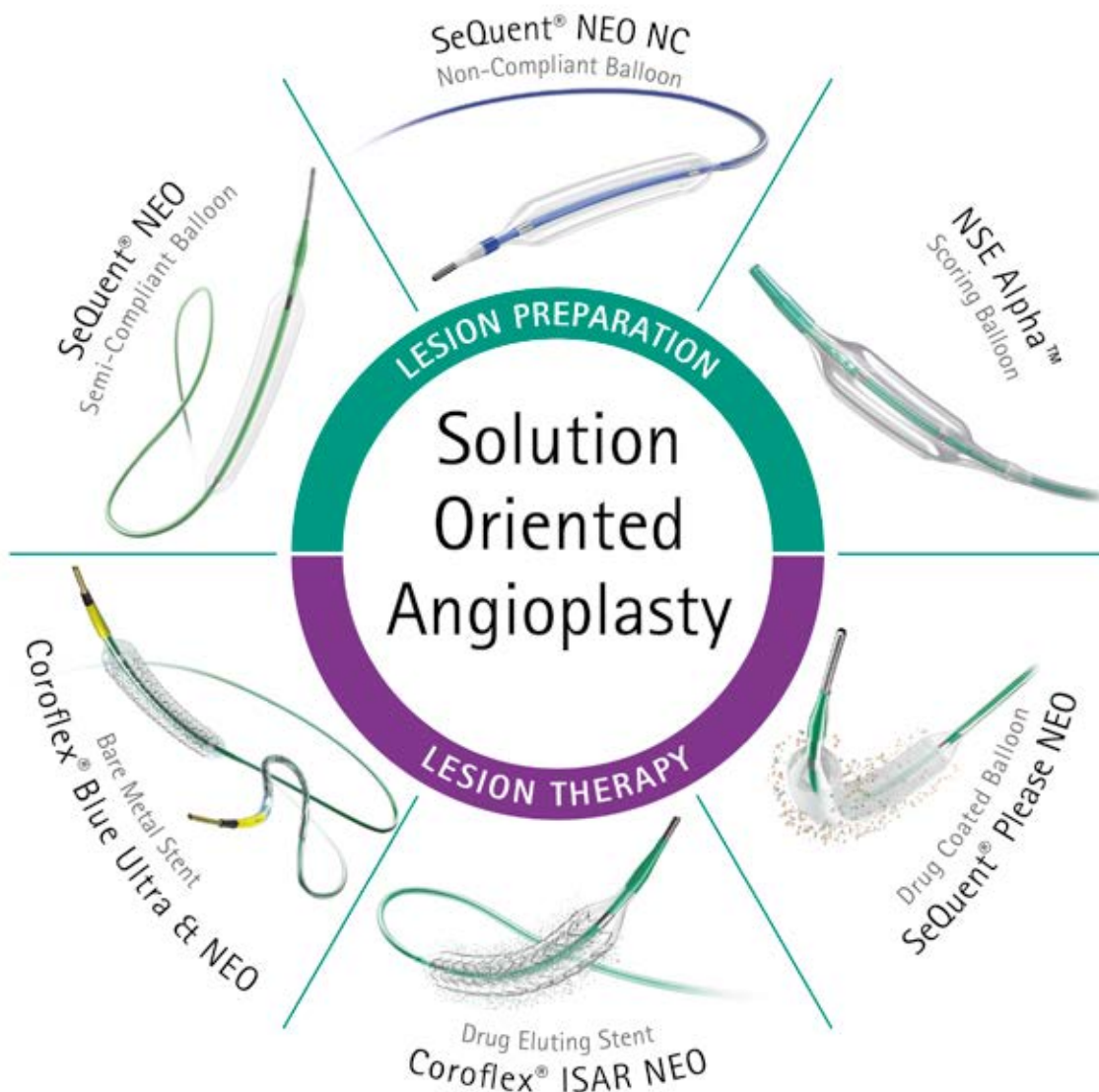

# VASCULAR SYSTEMS

## PRODUCTS FOR CARDIOLOGY

---

### DRUG ELUTING STENT SYSTEM

4 Coroflex® ISAR NEO

---

### BARE METAL STENT SYSTEM

5 Coroflex Blue® ULTRA

6 Coroflex Blue® NEO

---

### DRUG COATED BALLOON CATHETER

7 SeQuent® Please NEO

---

### PTCA BALLOON CATHETER

8 SeQuent® NEO

9 SeQuent® NEO NC

---

### SCORING BALLOON CATHETER

10 NSE Alpha™

---

### CORONARY GUIDING CATHETER

11 Serpia®

---

### ACCESSORIES FOR PTCA

12 Intradyn® PTCA

12 Metal Insertion Tool

13 Inflation Device for PTCA

13 Torquer

13 Y-Connector

13 Kissing BiBalloon Adapter

14 PTCA Kits

14 Bifurcation Kit

14 Fluid Collection System

---

### ANGIOGRAPHIC CATHETER

15 - 17 Diagnostic Catheters for Angiography

---

### ANGIODYN PROCEDURE KITS AND SERVICE

18 Standard Kits

19 Basic Set

---

### ANGIOGRAPHIC ACCESSORIES

20 Angiodyn® Guide Wires

21 - 22 Angiodyn® High Pressure Full-Body Manifolds

23 Angiodyn® High Pressure Tubing

24 Angiodyn® Syringes

24 Angiodyn® Contrast Saver System

24 Angiodyn® Contrast Saver Tubing

25 Angiodyn® Angiographic Syringes

25 Angiodyn® Injector Syringes

26 - 27 Angiodyn® Image Intensifier Covers and Bags

---

### CATHETER INTRODUCER SHEATH

28 Intradyn® Arterial

---

### INTRODUCER SHEATH (SELDINGER TECHNIQUE)

29 Intradyn® Tear-Away

---

30 Conversion Table

# Coroflex® ISAR NEO

NEXT GENERATION DRUG ELUTING STENT

## Technical Data



Stent material	Cobalt-chromium alloy L605
Stent strut thickness	55 µm (0.0022") for stents 2.0 – 3.0 mm 65 µm (0.0026") for stents 3.5 – 4.0 mm
Matrix coating technology	50:50 ratio (Sirolimus/ Probucol)
Drug load on stent	1.2 µg/mm <sup>2</sup>
Proximal shaft	1.9 F
Distal shaft	2.5 F
Usable length	145 cm
Guide wire compatibility	5 F (standard guiding catheter) 6 F (Kissing compatibility)
Lesion entry profile	0.016" (0.41 mm)
Crossing profile	0.031" - 0.033"
Nominal pressure (NP)	10 atm
Rated Burst Pressure (RBP)	18 atm (Ø 4.0: 15 atm)

Stent Diameter (mm)	Stent Length (mm)							
	9	12	16	19	24	28	32	38
2.0	5028910	5028917	5028924	5028931	5028938	5028945	5028952	5028959
2.25	5028911	5028918	5028925	5028932	5028939	5028946	5028953	5028960
2.5	5028912	5028919	5028926	5028933	5028940	5028947	5028954	5028961
2.75	5028913	5028920	5028927	5028934	5028941	5028948	5028955	5028962
3.0	5028914	5028921	5028928	5028935	5028942	5028949	5028956	5028963
3.5	5028915	5028922	5028929	5028936	5028943	5028950	5028957	5028964
4.0	5028916	5028923	5028930	5028937	5028944	5028951	5028958	5028965

Sales Unit (pcs.) 1

# Coroflex® Blue ULTRA

COBALT CHROMIUM CORONARY STENT SYSTEM

## Technical Data



Stent material	Cobalt-chromium alloy L605
Stent strut thickness	50 µm (0.0020")
Proximal shaft	1.9 F
Distal shaft	2.5 F
Usable length	145 cm
Guiding catheter compatibility	5 F
Guide wire compatibility	0.014"
Lesion entry profile	0.016" (0.41 mm)
Crossing profile	0.031" - 0.033"
Nominal pressure (NP)	10 atm
Rated Burst Pressure (RBP)	15 atm

Stent Diameter (mm)	Stent Length (mm)						
	9	14	16	19	24	27	32
2.0	5028807	5028817	5028827	5028837	5028847		
2.25	5028808	5028818	5028828	5028838	5028848	5028858	
2.5	5028809	5028819	5028829	5028839	5028849	5028859	5028869

Sales Unit (pcs.)	1
-------------------	---

# Coroflex® Blue NEO

## COBALT CHROMIUM CORONARY STENT SYSTEM

### Technical Data

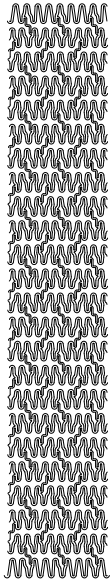

Stent material	Cobalt-chromium alloy L605
Stent strut thickness	65 µm (0.0026")
Proximal shaft	1.9 F
Distal shaft	2.5 F
Usable length	145 cm
Guiding catheter compatibility	5 F
Guide wire compatibility	0.014"
Lesion entry profile	0.016" (0.41 mm)
Crossing profile	0.033" - 0.035"
Nominal pressure (NP)	10 atm
Rated Burst Pressure (RBP)	15 atm (Ø 4.0: 12 atm)

Stent Diameter (mm)	Stent Length (mm)						
	8	13	16	19	24	27	32
2.75	5029012	5029022	5029032	5029042	5029062	5029072	5029082
3.0	5029013	5029023	5029033	5029043	5029063	5029073	5029083
3.5	5029014	5029024	5029034	5029044	5029064	5029074	5029084
4.0	5029015	5029025	5029035	5029045	5029065	5029075	5029085

Sales Unit      1  
(pcs.)

# SeQuent® Please NEO

NEXT GENERATION DRUG COATED BALLOON FOR PTCA

## Technical Data



Delivery system	Rapid Exchange
Proximal shaft	1.9 F
Distal shaft	2.5 F
Usable length	145 cm
Brachial & femoral marker	100 cm & 110 cm
Guiding catheter compatibility	5 F
Guide wire compatibility	0.014"
Tip profile	0.016"
Balloon compliance	Semi-compliant standard balloons
Crossing profile	0.033" - 0.037"
Nominal pressure (NP)	6 atm
Rated Burst Pressure (RBP)	14 atm

Balloon Diameter (mm)	Balloon Length (mm)						
	10	15	20	25	30	35	40
2.0	5023200	5023210	5023220	5023230	5023240	5023250	5023260
2.25	5023201	5023211	5023221	5023231	5023241	5023251	5023261
2.5	5023202	5023212	5023222	5023232	5023242	5023252	5023262
2.75	5023203	5023213	5023223	5023233	5023243	5023253	5023263
3.0	5023204	5023214	5023224	5023234	5023244	5023254	5023264
3.5	5023206	5023216	5023226	5023236	5023246	5023256	5023266
4.0	5023207	5023217	5023227	5023237	5023247	5023257	5023267

Sales Unit (pcs.)	1
-------------------	---

# SeQuent® NEO

## PTCA BALLOON CATHETER

### Technical Data

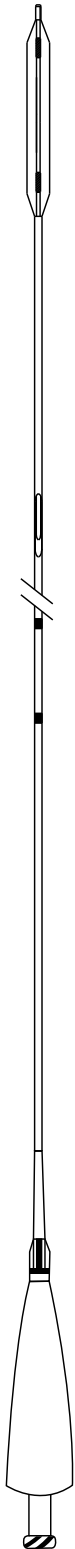

Delivery system	Rapid Exchange
Proximal shaft	1.9 F
Distal shaft	2.5 F
Usable length	145 cm
Brachial & femoral marker	100 cm & 110 cm
Guiding catheter compatibility	5 F / "Kissing" balloon in 6 F
Guide wire compatibility	0.014"
Tip profile	0.016"
Balloon compliance	Semi-compliant standard balloons Non-compliant 1.25 mm & 1.5 mm balloons
Crossing profile	0.023" - 0.026"
Nominal pressure (NP)	6 atm (Ø 1.25 - 1.5: 10 atm)
Rated Burst Pressure (RBP)	14 atm (Ø 1.25 - 1.5: 18 atm)

Balloon Diameter (mm)	Balloon Length (mm)				
	10	15	20	25	30
1.25	5021711D	5021721D	5021731D		
1.5	5021712D	5021722D	5021732D		
2.0	5021713D	5021723D	5021733D	5021743D	5021753D
2.25	5021714D	5021724D	5021734D	5021744D	5021754D
2.5	5021715D	5021725D	5021735D	5021745D	5021755D
2.75	5021716D	5021726D	5021736D	5021746D	5021756D
3.0	5021717D	5021727D	5021737D	5021747D	5021757D
3.5	5021718D	5021728D	5021738D	5021748D	5021758D
4.0	5021719D	5021729D	5021739D	5021749D	5021759D

Sales Unit (pcs.)	1
-------------------	---

Material codes for SeQuent® NEO products might differ slightly in your country. Please contact one of our product specialists for more information.



# SeQuent® NEO NC

CORONARY NON-COMPLIANT BALLOON CATHETER

## Technical Data

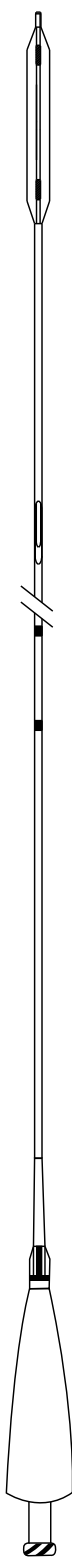

Delivery system	Rapid Exchange
Balloon material	Nylon
Proximal shaft	1.9 F
Distal shaft	2.7 F
Usable length	140 cm
Brachial & femoral marker	90 cm & 100 cm
Guiding catheter compatibility	5 F
Guide wire compatibility	0.014"
Lesion entry profile	0.016" (0.41 mm)
Balloon compliance	Non-compliant standard balloon
Nominal pressure (NP)	12 atm
Rated Burst Pressure (RBP)	20 atm

Balloon Diameter (mm)	Balloon Length (mm)					
	8	10	12	15	20	30
2.0	5023900	5023910	5023920	5023930	5023940	5023960
2.25	5023901	5023911	5023921	5023931	5023941	5023961
2.5	5023902	5023912	5023922	5023932	5023942	5023962
2.75	5023903	5023913	5023923	5023933	5023943	5023963
3.0	5023904	5023914	5023924	5023934	5023944	5023964
3.5	5023906	5023916	5023926	5023936	5023946	5023966
4.0	5023907	5023917	5023927	5023937	5023947	5023967
4.5	5023908	5023918	5023928	5023938	5023948	5023968
Sales Unit (pcs.)	1					

# NSE Alpha™

CORONARY SCORING BALLOON CATHETER FOR COMPLEX LESIONS

## Technical Data

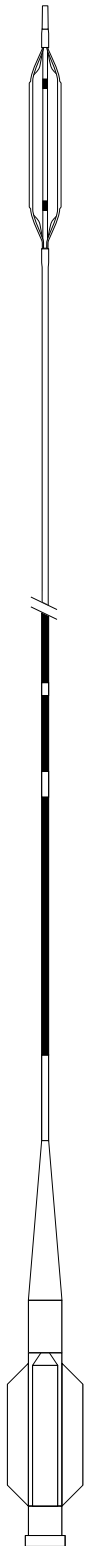

Delivery system	Rapid Exchange
Scoring elements	3
Material of the scoring elements	Nylon
Proximal shaft	2.1 F
Distal shaft	2.7 F
Usable length	143 cm
Brachial & femoral marker	93 cm & 103 cm
Guiding catheter compatibility	6 F
Guide wire compatibility	0.014"
Lesion entry profile	0.016"
Nominal pressure (NP)	6 atm
Rated Burst Pressure (RBP)	20 atm

Balloon Diameter (mm)	Balloon Length (13 mm)
2.0	NSA20013
2.25	NSA22513
2.5	NSA25013
2.75	NSA27513
3.0	NSA30013
3.5	NSA35013
4.0	NSA40013

Sales Unit (pcs.)	1
-------------------	---

	5 French (Inner diameter: 0.058")		6 French (Inner diameter: 0.071")		7 French (Inner diameter: 0.082")	
	Configuration	Reference	Configuration	Reference	Configuration	Reference
- Usable length 100 cm	AL 0.75	25400105	AL 0.75	26400105	AL 1 SH	27400225
- Hydrophilic coated catheter shaft	AL 1	25400205	AL 0.75 SH	26400125	AL 2 SH	27400325
- Kissing balloon capable	HS	25401505	AL 1	26400205	AL 3 SH	27400425
- Atraumatic tip	JL 3.5	25402105	AL 1 SH	26400225	AR 1 SH	27400525
	JL 4	25402205	AL 1.5	26401005	AR 2 SH	27400725
	JR 3.5	25402705	AL 1.5 SH	26401025	HS SH	27401525
	JR 4	25402805	AL 2	26400305	JL 3 SH	27402025
	MPA	25403605	AL 2 SH	26400325	JL 3.5 SH	27402125
	RAD	25405005	AR 1	26400505	JL 4 SH	27402225
	TIG4	25407005	AR 1 SH	26400525	JL 4.5 SH	27402325
	XB 3.5	25407505	AR 2	26400705	JL 5 SH	27402425
	XB 4	25407605	AR 2 SH	26400725	JR 3.5 SH	27402725
	EBU 3.5	25408805	HS	26401505	JR 4 SH	27402825
	EBU 3.75	25408905	IM	26401705	JR 4.5 SH	27402925
	EBU 4	25409005	IM SH	26401725	JR 5 SH	27403025
			JL 3	26402005	MPA SH	27403625
			JL 3 SH	26402025	EBU 3 SH	27408625
			JL 3.5	26402105	EBU 3.5 SH	27408825
			JL 3.5 SH	26402125	EBU 3.75 SH	27408925
			JL 4	26402205	EBU 4 SH	27409025
			JL 4 SH	26402225	EBU 4.5 SH	27409225
			JL 5	26402405		
			JL 5 SH	26402425		
			JR 3.5	26402705		
			JR 3.5 SH	26402725		
			JR 4	26402805		
			JR 4 SH	26402825		
			JR 4.5 SH	26402925		
			JR 5	26403005		
			MPA	26403605		
			MPA SH	26403625		
			RAD	26405005		
			RCB	26405505		
			TIG 4	26407005		
			XB 3	26407305		
			XB 3.5	26407505		
			XB 3.5 SH	26407525		
			XB 4	26407605		
			XB 4 SH	26407625		
			XB 4.5	26407705		
			EBU 3	26408605		
			EBU 3 SH	26408625		
			EBU 3.5	26408805		
			EBU 3.5 SH	26408825		
			EBU 3.75 SH	26408925		
			EBU 4	26409005		
			EBU 4 SH	26409025		

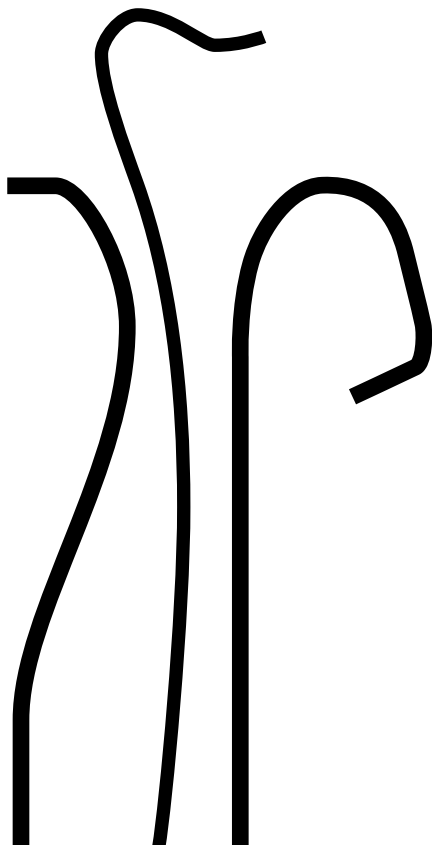

# ACCESSORIES FOR PTCA

## INTRODUCER, METAL INSERTION TOOL

### Intradyn PTCA

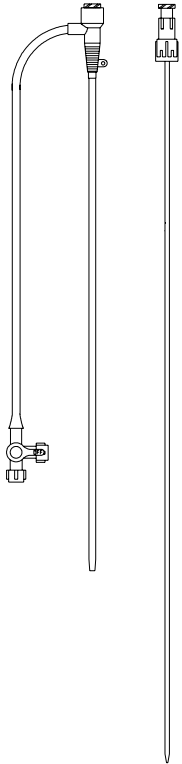

Intradyn is an introducer for Percutaneous Transluminal Coronary Angioplasty.

- **Sheath 230 mm made of FEP**
  - With hemostasis valve
  - Side port with three-way stopcock
  - Collar and suture hub
- **Dilatator 280 mm made of PE**
  - Atraumatic tip
  - Luer Lock connection between sheath and dilatator

Product Description	Code-Number	Sales Unit (pcs.)
Intradyn® PTCA F8 blue	5215161	5

### Metal Insertion Tool



Gauge	Length (cm)	Color	Code-Number	Sales Unit (pcs.)
20	75	Transparent	5017826	20

# ACCESSORIES FOR PTCA

INFLATION DEVICE, Y-CONNECTOR, KISSING BIBALLOON ADAPTER

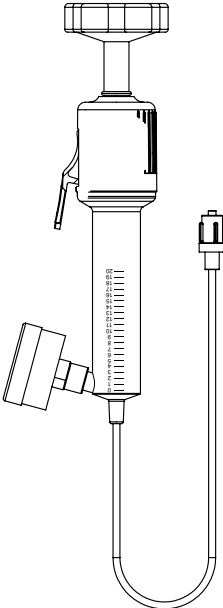
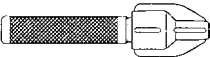
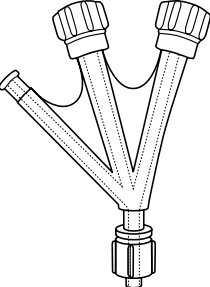
	Inflation Device for PTCA	Code-Number	Sales Unit (pcs.)
	<p>This inflation device is a component in PTCA-Kit 3 and PTCA-Kit 4 presented on the next page.</p> <ul style="list-style-type: none"> <li>▪ <b>Pressure Gauge</b> <ul style="list-style-type: none"> <li>– 90° rotating manometer</li> <li>– Coded figures from nominal to burst pressures</li> </ul> </li> <li>▪ <b>Body and Handle</b> <ul style="list-style-type: none"> <li>– Ergonomic handle</li> <li>– Clear material for air detection and de-bubbling</li> </ul> </li> </ul>		
	<p>Inflation device for PTCA, 20 ml/30 atm</p>	<p><b>5028901</b></p>	<p>1</p>
	<p><b>Torquer</b>            The torquer is designed for guide wires.</p> <ul style="list-style-type: none"> <li>– Luminescent</li> <li>– Wire grip for all diameters up to 0.022"</li> </ul>		
	<p>Torquer</p>	<p><b>5023687</b></p>	<p>10</p>
	<p><b>Y-Connector</b></p> <ul style="list-style-type: none"> <li>– With rotational adaptor and Tuohy-Borst-valve</li> <li>– 9.5 F lumen</li> </ul>		
	<p>Y-connector with plastic insertion tool</p>	<p><b>5021693</b></p>	<p>10</p>
	<p>Double Y-connector with plastic insertion tool</p>	<p><b>5020743</b></p>	<p>5</p>
	<p><b>Kissing BiBalloon Adaptor</b>            The Kissing BiBalloon adaptor enables the simultaneous and/ or sequential dilatation of bifurcation lesions.</p> <p>Kissing BiBalloon adaptor</p>	<p><b>5014760</b></p>	<p>25</p>

# ACCESSORIES FOR PTCA

PTCA-KITS, BIFURCATION KIT, FLUID COLLECTION SYSTEM

	Code-Number	Sales Unit (pcs.)
<p><b>PTCA-Kit 2</b></p> <ul style="list-style-type: none"> <li>- Y-connector with metal insertion tool</li> <li>- Torquer, luminescent wire grip for all diameters up to 0.022"</li> </ul> <p>PTCA-Kit 2</p>	5028550	10
<p><b>PTCA-Kit 3</b></p> <ul style="list-style-type: none"> <li>- Y-connector with metal insertion tool</li> <li>- Torquer, luminescent wire grip for all diameters up to 0.022"</li> <li>- Inflation device for PTCA</li> </ul> <p>PTCA-Kit 3</p>	5028902	1
<p><b>PTCA-Kit 4</b></p> <ul style="list-style-type: none"> <li>- Y-connector, insertion tool and torquer</li> <li>- High pressure 3-way stopcock</li> <li>- Inflation device for PTCA</li> </ul> <p>PTCA-Kit 4</p>	5028905	1
<p><b>Bifurcation Kit</b></p> <ul style="list-style-type: none"> <li>- Inflation device</li> <li>- Double Y-connector</li> <li>- Kissing Balloon adaptor</li> <li>- Insertion tool and torquer</li> </ul> <p>Bifurcation Kit</p>	5028904	1
<p><b>Fluid Collection System</b></p> <ul style="list-style-type: none"> <li>- Aspiration of liquids (saline solution, contrast media)</li> <li>- Disposal of aspiration liquid in a closed container (bag)</li> <li>- Tubing length to dual check valve: 190 cm</li> <li>- Tubing length to container: 180 cm</li> <li>- Container volume: 1000 ml</li> </ul> <p>Fluid collection system</p>	5010555	50

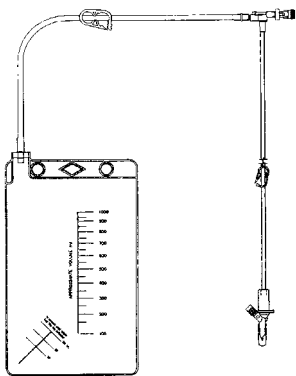

# ANGIOGRAPHIC CATHETER

## DIAGNOSTIC CATHETERS FOR ANGIOGRAPHY

- High kink resistance
- Maximal control and 1:1 force transmission due to symmetrically braided shaft
- Atraumatic rounded distal tip design
- Facilitated identification due to color coded French sizes

### 4 French (red)

	Selective	Pigtail
Outer diameter body & tip	0.055"/ 1.4 mm	0.055"/ 1.4 mm
Inner diameter body	0.042"/ 1.12 mm	0.042"/ 1.12 mm
Inner diameter tip	0.042"/ 1.07 mm	0.042"/ 1.07 mm

### 5 French (grey)

	Selective	Pigtail
Outer diameter body & tip	0.065"/ 1.65 mm	0.065"/ 1.65 mm
Inner diameter body	0.050"/ 1.27 mm	0.050"/ 1.27 mm
Inner diameter tip	0.047"/ 1.18 mm	0.042"/ 1.07 mm

### 6 French (green)

	Selective	Pigtail
Outer diameter body & tip	0.079"/ 2.0 mm	0.079"/ 2.0 mm
Inner diameter body	0.057"/ 1.44 mm	0.057"/ 1.44 mm
Inner diameter tip	0.057"/ 1.44 mm	0.042"/ 1.07 mm

# ANGIOGRAPHIC CATHETER



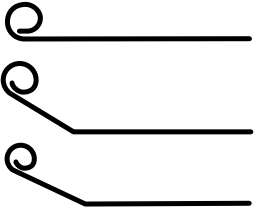
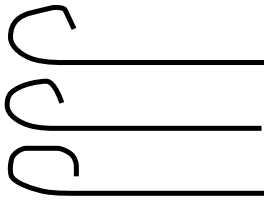
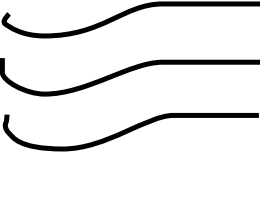
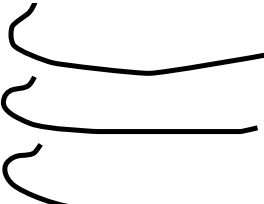
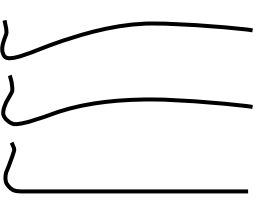
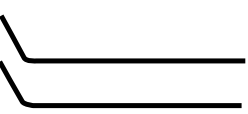

## DIAGNOSTIC CATHETERS FOR ANGIOGRAPHY

	Shape Description	Length (cm)	Code-Number 4 French	Code-Number 5 French	Code-Number 6 French	Sales Unit (pcs.)
	<b>Pigtail - catheter for ventriculography - 8 sideholes</b>					
	PIG	110	5011573	5011536	5011521	5
	PIG	130	5011592	5011527	5011526	5
	PIG 145	110	5011595	5011572	5011525	5
	PIG 145	130	5011577	5011503	5011569	5
	PIG 155	110	5011534	5011541	5011528	5
	PIG 155	130	5011532	5011557	5011502	5
	<b>Judkins - catheter for the left coronary artery</b>					
	JL 3.0	100	5011635	5011612	5011631	5
	JL 3.5	100	5011594	5011512	5011511	5
	JL 4.0	100	5011563	5011545	5011517	5
	JL 4.5	100	5011644	5011613	5011632	5
	JL 5.0	100	5011514	5011586	5011518	5
	JL 6.0	100	5011677	5011614	5011634	5
	<b>Judkins - catheter for the right coronary artery</b>					
	JR 3.0	100	5011688	5011615	5011650	5
	JR 3.5	100	5011588	5011535	5011589	5
	JR 4.0	100	5011500	5011546	5011508	5
	JR 4.5	100	5011699	5011617	5011649	5
	JR 5.0	100	5011576	5011558	5011509	5
	JR 6.0	100	5011600	5011618	5011636	5
	<b>Amplatz - catheter for the left coronary artery</b>					
	AL1	100	5011552	5011582	5011548	5
	AL2	100	5011599	5011565	5011550	5
	AL3	100	5011506	5011520	5011553	5
	<b>Amplatz - catheter for the right coronary artery</b>					
	AR1MOD	100	5011513	5011551	5011530	5
	AR2MOD	100	5011537	5011516	5011542	5
	ARMOD	100	5011522	5011529	5011547	5
	<b>Multi Purpose catheter</b>					
	MPA	100	5011501	5011561	5011564	5
	MPA2	100	5011580	5011540	5011556	5
	MPB	100	5011611	5011575	5011637	5
	MPB2	100	5011622	5011581	5011638	5

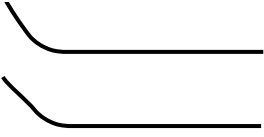

# ANGIOGRAPHIC CATHETER

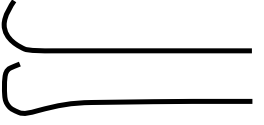
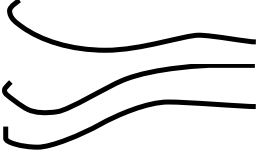
## DIAGNOSTIC CATHETERS FOR ANGIOGRAPHY

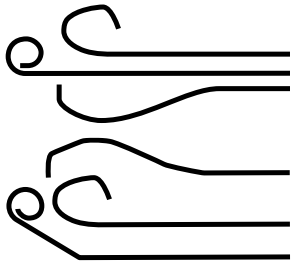
	Shape Description	Length (cm)	Code-Number 4 French	Code-Number 5 French	Code-Number 6 French	Sales Unit (pcs.)
	<b>Williams</b>					
	3DS	100	5011596	5011597	5011598	5
	<b>Sones catheter - 2 sideholes</b>					
	Sones1	100	5011603	5011619	5011639	5
	Sones1/2	100	5011539	5011570	5011554	5
	Sones2	100	5011604	5011621	5011640	5
	Sones2/2	100	5011111	5011593	5011559	5
	<b>Gamal</b>					
	Gamal	100	5011605	5011624	5011641	5
	<b>Radial</b>					
	RAD	100	5014444	5011543	5011544	5
	TIG2	100	5011606	5011625	5011642	5
	<b>Bypass catheter</b>					
	IM	100	5011533	5011505	5011562	5
	LCB	100	5012222	5011591	5011510	5
	RCB	100	5013333	5011560	5011519	5
	<b>Duo-Pack</b>					
	JL4/JR4	100/100	5011607	5011626	5011643	5
	JL4/3DS	100/100		5011712		5
	<b>Multipack</b>					
	JL4/JR3.5/PIG	100/100/110	5011609	5011628	5011646	5
	JL3.5/JR4/PIG145	100/100/110	5011608	5011627	5011645	5
	JL4/JR4/PIG	100/100/110	5011538	5011549	5011567	5
	JL4/JR4/PIG145	100/100/110	5014892	5011524	5011568	5
	3DS/JL4/PIG145	100/100/110	5011610	5011629	5011647	5
	ARMOD/JL4/PIG145	100/100/110		5011630		5
	3DS/JL4/PIG	100/100/110			5011648	5

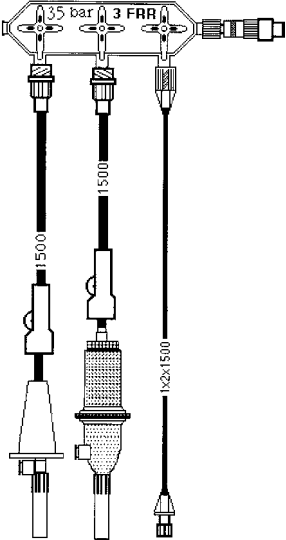
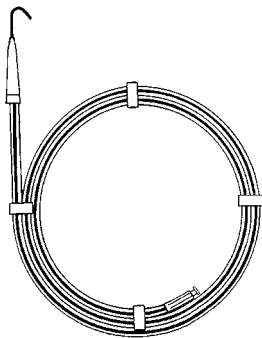
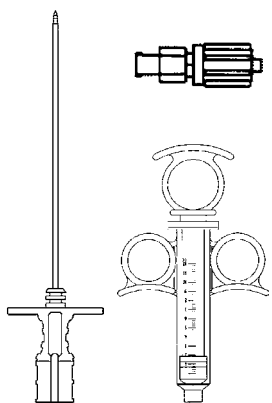
	Code-Number	Sales Unit (pcs.)
 <p><b>Manifold assembly 3-way, OFF</b></p> <ul style="list-style-type: none"> <li>- High pressure manifold, 3-way, OFF, connected with contrast media tubing, Intrafix air and Combidyn tubing</li> <li>- Angiographic syringe 10 ml</li> <li>- Arterial puncture needle (Seldinger) 18 G</li> <li>- Cutfix scalpel Fig. 11</li> </ul>	<b>5010660</b>	25
<p><b>Manifold assembly 2-way, OFF</b></p> <ul style="list-style-type: none"> <li>- High pressure manifold, 2-way, OFF, connected with contrast media tubing and Combidyn tubing</li> <li>- Angiographic syringe 10 ml</li> <li>- Arterial puncture needle (Seldinger) 18 G</li> <li>- Cutfix scalpel Fig. 11</li> </ul>	<b>5010440</b>	25
 <p><b>Manifold assembly 3-way, ON</b></p> <ul style="list-style-type: none"> <li>- High pressure manifold, 3-way, ON, connected with contrast media tubing, Intrafix air and Combidyn tubing</li> <li>- Angiographic syringe 10 ml</li> <li>- Arterial puncture needle (Seldinger) 18 G</li> <li>- Cutfix scalpel Fig. 11</li> </ul>	<b>5010220</b>	25
 <p><b>Angiography kit 3-way, OFF</b></p> <ul style="list-style-type: none"> <li>- High pressure manifold, 3-way, OFF, connected with contrast media tubing, Intrafix air and Combidyn tubing</li> <li>- Angiographic syringe 10 ml</li> <li>- Arterial puncture needle (Seldinger) 18 G</li> <li>- Cutfix scalpel Fig. 11</li> <li>- Angiographic drape with 2 transparent windows</li> <li>- Standard guide wire, 150 cm, J3-tip, 0.035"</li> <li>- Gauze, 10 x 10 cm, 12-ply</li> <li>- Sterican needle, G 21 green</li> <li>- Sterican needle, G 22 black</li> <li>- Omnifix syringe LL, 5 ml</li> <li>- Omnifix syringe LL, 10 ml</li> <li>- Tray, 27 x 22 x 4 cm</li> <li>- Cover drape 100 x 150 cm</li> </ul>	<b>5010550</b>	4

Basic Set	Code-Number	Sales Unit (pcs.)
<ul style="list-style-type: none"> <li>- Nosebag 108 x 50 x 80 cm</li> <li>- Image intensifier cover 75 x 80 cm</li> <li>- Image intensifier cover 90 x 90 cm</li> <li>- Bowl transparent 500 ml</li> <li>- Universal clamp</li> <li>- Guide wire bowl blue 2500ml</li> <li>- Syringe Omnifix 10 ml, LL</li> <li>- Syringe Omnifix 10 ml, LS</li> <li>- Syringe Omnifix 5 ml, LS</li> <li>- Puncture needle 1,3 x 70 mm, 18G</li> <li>- Sterican 0,90 x 40 mm, 20G, yellow</li> <li>- Sterican 0,70 x 30 mm, 22G, black</li> <li>- Bowl 120 ml transparent</li> <li>- Bowl 250 ml transparent</li> <li>- Swab balls plum size</li> <li>- Gauze pad 10 x 10 cm</li> <li>- Coat size. XL</li> <li>- Angio drape 240 x 380 cm, 4 holes</li> <li>- Lamp cover</li> <li>- Guide wire J3FC-FS 150-035</li> <li>- Cutfix scalpel Fig. 11</li> <li>- Image intensifier cover 35 x 70 cm</li> <li>- Image intensifier cover 120 x 120 cm</li> <li>- Cover drape 150 x 90 cm</li> <li>- Cover drape 152 x 190 cm</li> </ul> <p>Basic Set</p>	<b>5014218</b>	4
<p>Add on Basic Kit</p> <ul style="list-style-type: none"> <li>- Wrap drape 137 x 137 cm</li> <li>- Surgical drape 45 x 45 cm, 6-ply, with x-ray</li> <li>- Image intensifier cover 35 x 70 cm</li> <li>- Image intensifier bag 100 x 100 cm</li> <li>- Incision foil 30 x 26 cm</li> <li>- Tray 25,0 x 13,7 x 5,0 cm</li> <li>- Image intensifier cover 140 x 140 cm</li> <li>- Universal clamp</li> <li>- Cutfix scalpel Fig. 11</li> </ul> <p>Add on Basic Kit</p>	<b>5014219</b>	10

# Angiodyn®

## GUIDE WIRES, PTFE-COATED

### Angiodyn® Guide Wires

Guide wires for insertion, stabilization and positioning of angiographic catheters.

- PTFE-coated stainless nickel-chromium steel
- Flexible and rounded wire tip
- Straightener (only for J-tip)
- Standard: With dispenser and Luer Lock-fitting for flushing the wire

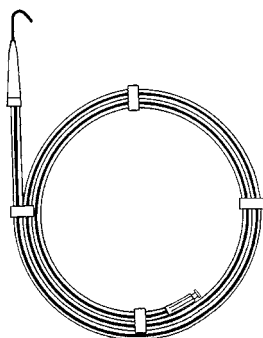

Product Description	Length (cm)	Diameter (inch/mm)	Code-Number	Sales Unit (pcs.)
<b>J-tip, fixed core (FC), fingerstraightenable (FS)</b>				
J3 FC-FS 150-035	150	0.035/0.89	<b>5050200</b>	10
J3 FC-FS 150-038	150	0.038/0.97	<b>5050219</b>	10
J3 FC-FS 175-035	175	0.035/0.89	<b>5059755</b>	50
J3 FC-FS 200-035	200	0.035/0.89	<b>5050980</b>	50
J3 FC-FS 220-035	220	0.035/0.89	<b>5050981</b>	50
J3 FC-FS 260-035	260	0.035/0.89	<b>5050359</b>	5
J3 FC-FS 260-038	260	0.038/0.97	<b>5050367</b>	5
<b>Straight tip (S), fixed core (FC)</b>				
SFC 150-018	150	0.018/0.46	<b>5050456</b>	10
SFC 150-035	150	0.035/0.89	<b>5050243</b>	10
SFC 150-038	150	0.038/0.97	<b>5050251</b>	10
SFC 260-038	260	0.038/0.97	<b>5050430</b>	5
<b>J-tip, movable core (M), fingerstraightenable (FS)</b>				
J3 MC-FS 150-032	150	0.032/0.81	<b>5056470</b>	10
J3 MC-FS 150-035	150	0.035/0.89	<b>5050235</b>	10
J3 MC-FS 200-035	200	0.035/0.89	<b>5050308</b>	10
<b>J-tip and straight tip (S) (flexible on both ends) fixed core (FC), fingerstraightenable (FS)</b>				
J3 SFC-FS 150-035	150	0.035/0.89	<b>5050227</b>	10
J3 SFC-FS 150-038	150	0.038/0.97	<b>5051022</b>	50
J3 SFC-FS 175-035	175	0.035/0.89	<b>5059208</b>	50
J3 SFC-FS 220-035	220	0.035/0.89	<b>5050360</b>	5

# Angiodyn®

## MID AND HIGH PRESSURE FULL-BODY MANIFOLDS

### Angiodyn® Mid and High Pressure Full-Body Manifold

- Handles with ergonomic design
- Transparent housing for visual control
- Stopcocks tested up to 70 bar (1000 psi) pressure stability for machine injections (yellow)
- Stopcocks tested up to 35 bar (500 psi) pressure stability for manual injections (grey)
- Without rotating adaptor but with female Luer Lock-fitting
- With rotating adaptor and male Luer Lock-fitting for catheter connection

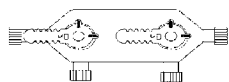

#### Manifolds 2-port ON version, grey handles

Pressure Stability (bar)	Connections	Description	Code-Number	Sales Unit (pcs.)
35	Rotating adaptor male right	2 OR 35	<b>5012759</b>	50
70	Rotating adaptor male right	2 ORR 70	<b>5012783</b>	50

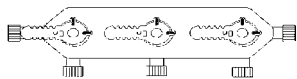

#### Manifolds 3-port ON version, grey handles

35	Rotating adaptor male right	3 ORR 35	<b>5012813</b>	50
70	Rotating adaptor male right	3 ORR 70	<b>5012848</b>	50

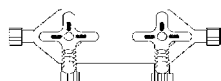

#### Manifolds 2-port OFF version, yellow handles

35	Rotating adaptor male right	2 FRR 35	<b>5012112</b>	50
70	All female	2 FF 70	<b>5012015</b>	50
70	Rotating adaptor male right	2 FRR 70	<b>5012104</b>	50

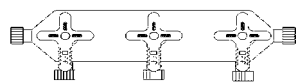

#### Manifolds 3-port OFF version, yellow handles

35	Rotating adaptor male right	3 FRR 35	<b>5012074</b>	50
70	Rotating adaptor male right	3 FRR 70	<b>5012066</b>	50

# Angiodyn® Softgrip

## MID AND HIGH PRESSURE FULL-BODY MANIFOLDS

### Angiodyn® Mid and High Pressure Full-Body Manifold

- Handles with ergonomic design
- Transparent housing for visual control
- Stopcocks tested up to 70 bar (1000 psi) pressure stability for machine injections (dark grey)
- Stopcocks tested up to 35 bar (500 psi) pressure stability for manual injections (light grey)
- With rotating adaptor and male Luer Lock-fitting for catheter connection
- Colored handles

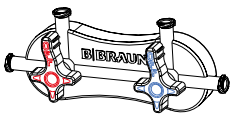
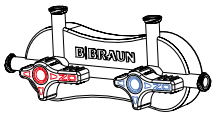
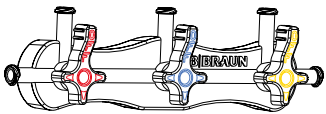
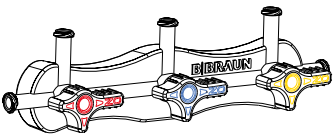
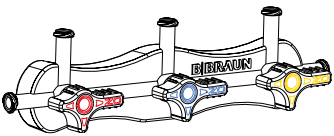
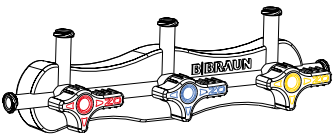
	Pressure Stability (bar)	Code-Number	Sales Unit (pcs.)
	<b>Manifold Softgrip 2-port OFF version</b>		
	35	<b>5011406</b>	50
	<b>Manifold Softgrip 2-port ON version</b>		
	70	<b>5010576</b>	50
	<b>Manifold Softgrip 3-port OFF version</b>		
	35	<b>5011404</b>	50
	<b>Manifold Softgrip 3-port ON version</b>		
	70	<b>5010575</b>	50
	<b>Manifold Softgrip 3-port ON version</b>		
	35	<b>5016131</b>	50
	<b>Manifold Softgrip 3-port ON version</b>		
	70	<b>5010579</b>	50

# Angiodyn®

## HIGH PRESSURE TUBING WITH/ WITHOUT ROTATING ADAPTOR

### Angiodyn® High Pressure Tubing

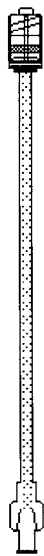

#### Angiodyn® High Pressure Tubing up to 84 bar (1200 psi)

– Braided PUR, very flexible

##### Male/Female with Rotating Adaptor

Length (cm)	Inner Diameter (mm)	Outer Diameter (mm)	Code-Number	Sales Unit (pcs.)
25	1.75	3.6	<b>5018864</b>	25
50	1.75	3.6	<b>5011507</b>	25
75	1.75	3.6	<b>5011515</b>	25
100	1.75	3.6	<b>5011523</b>	25
120	1.75	3.6	<b>5011531</b>	25
200	1.75	3.6	<b>5016002</b>	25

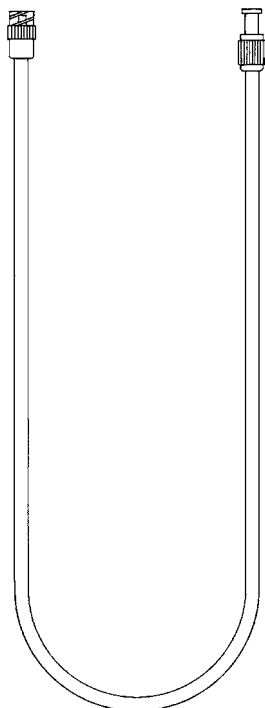

#### Angiodyn® High Pressure Tubing up to 70 bar (1000 psi)

– PVC, flexible

##### Male/Female with Rotating Adaptor

Length (cm)	Inner Diameter (mm)	Outer Diameter (mm)	Code-Number	Sales Unit (pcs.)
25	2.0	4.75	<b>5014824</b>	20
50	2.0	4.75	<b>5011957</b>	20
75	2.0	4.75	<b>5011965</b>	20
100	2.0	4.75	<b>5011973</b>	20
120	2.0	4.75	<b>5011938</b>	20
150	2.0	4.75	<b>5018580</b>	25
180	2.0	4.75	<b>5218088</b>	25

##### Male/Female without Rotating Adaptor

Length (cm)	Inner Diameter (mm)	Outer Diameter (mm)	Code-Number	Sales Unit (pcs.)
50	2.0	4.75	<b>5018196</b>	20
75	2.0	4.75	<b>5018200</b>	20
100	2.0	4.75	<b>5018218</b>	20
120	2.0	4.75	<b>5018233</b>	20
150	2.0	4.75	<b>5014875</b>	20

### Spectraline Disposable Syringes for Connection with Manifolds and Catheters

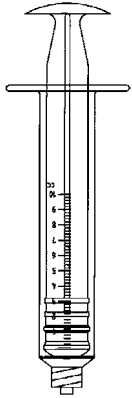

- For injection of contrast media, heparin, saline solution and other liquids by hand
- Clear polycarbonate barrel provides easy visualization of fluid levels and allows de-bubbling
- Wider barrel flanges
- Ergonomic palm plunger
- 10 ml and 20 ml syringes available in five colors
- Each syringe is individually packaged with a label set

Plunger Color	Type	Syringe Volume (ml)	Code-Number	Sales Unit (pcs.)
White	SP 10 W	10	<b>5018991</b>	25
Blue	SP 10 B	10	<b>5018993</b>	25
Green	SP 10 G	10	<b>5018996</b>	25
Yellow	SP 10 Y	10	<b>5018997</b>	25
Red	SP 10 R	10	<b>5018992</b>	25
White	SP 20 W	20	<b>5018998</b>	25
Blue	SP 20 B	20	<b>5019004</b>	25
Green	SP 20 G	20	<b>5019006</b>	25
Yellow	SP 20 Y	20	<b>5019013</b>	25
Red	SP 20 R	20	<b>5019016</b>	25

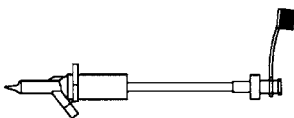

#### Contrast Saver System

- System for saving contrast media

#### Contrast Saver Spike

- Ventilated spike for contrast media container with Safesite valve
- Applicable for several angiographic examinations
- With integrated cover cap
- Length 15 cm

Contrast saver spike

**5010557**

50



#### Contrast Saver Tubing

- Connection between contrast saver spike and manifold
- With large bore check valve to close the contrast media container (to prevent contamination with micro organisms)
- Length 140 cm

Contrast saver tubing

**5010552**

50

Contrast saver burette (without illustration)

**5012000**

50



# Angiodyn®

## ANGIOGRAPHIC SYRINGES / INJECTOR SYRINGES

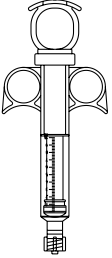
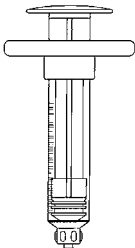
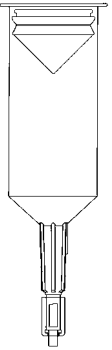
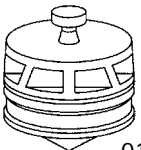
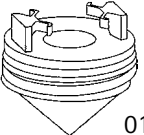
Angiodyn®			Code-Number	Sales Unit (pcs.)	
	<b>Angiographic syringes perform contrast media injections.</b> – Rubber gasket for smooth plunger action with double seal – Crystal clear barrel				
	<b>10 ml Angiographic Syringe with Rotating Adapter</b> – Ring plunger and medium sized grip plate – Security stop at 1.0 ml – Lateral finger rings				
	10 ml angiographic syringe with rotating adapter		<b>5011990</b>	50	
	<b>10 ml Angiographic Syringe with Male Luer Lock-Fitting</b> – Medium sized grip plate – Security stop at 1.0 ml				
	10 ml angiographic syringe with male Luer Lock-fitting				
			<b>5010142</b>	50	
	<b>Angiodyn® Injector Syringes</b> – Developed for high pressure injectors up to 84 bar / 1200 psi – Transparent, polypropylene for easy identification of air bubbles – Plunger with double seal prevents air aspiration and leakage – Protective cap to avoid contamination when using aseptic technique – Connection to all Luer standards possible				
	0137NE	150 ml	Angiomat 6000 TM	<b>5010200</b>	50
	0137NF	150 ml	Medrad (Mark V)	<b>5010207</b>	50
 0137 NE					
 0137 NF					
<b>Additional Tubing (without illustration)</b> – Facilitates filling contrast media into injection syringes					
Additional tubing			<b>5017000</b>	100	

# Angiodyn®

## IMAGE INTENSIFIER COVERS AND BAGS

### Angiodyn® Image Intensifier Covers and Bags

- Protect your equipment from contamination and dust
- PE transparent cover
- With elastic or string fixation

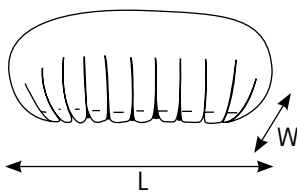

#### Angiodyn® Image Intensifier Cover with Elastic Fixation

Length = L (cm)	Width = W (cm)	Code- Number	Sales Unit (pcs.)
35	70	5014022	25
45	45	5016733	25
75	80	5010438	25
75	100	5010446	25
80	120	5213568	25
90	90	5017582	25
110	110	5015649	25
120	120	5010085	25
140	140	5018912	25

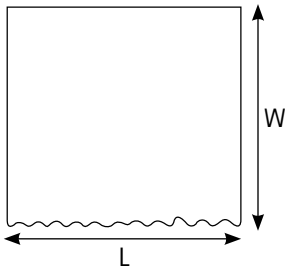

#### Angiodyn® Image Intensifier Bag with Elastic Fixation

60	60	5016080	25
80	45	5015210	25
80	100	5019520	25
85	90	5019900	25
90	60	5010210	25
90	100	5012629	25
100	100	5014983	25
110	130	5015640	25

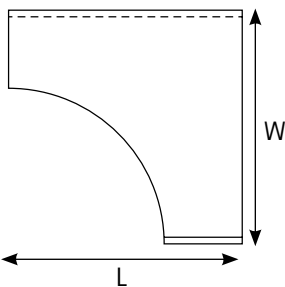

#### Angiodyn® Image Intensifier Bag (nose type)

80	80	5018100	50
82	95	5019430	50
117	90	5011179	50

#### Angiodyn® Bag with String Fixation

60	65	5017745	25
----	----	---------	----

#### Angiodyn® Lamp Handle Cover (without illustration)

		5016255	100
--	--	---------	-----

#### Angiodyn® Table Plastic Cover (without illustration) Color: Blue

60	65	5012606	25
----	----	---------	----

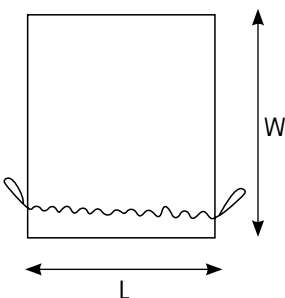

# Angiodyn®

## IMAGE INTENSIFIER COVERS AND BAGS

	Length (cm)	Width (cm)	Code- Number	Sales Unit (pcs.)
	<b>Angiodyn® Protection Cover Radial</b>			
	86	41	<b>5012119</b>	50
	<b>Angiodyn® Protection Cover Femoral</b>			
	86	40	<b>5019113</b>	50
	<b>Angiodyn® Monitor Hand Cover (without illustration)</b>			
	160	30	<b>5013308</b>	50
	<b>Angiodyn® Remote Control Cover with Cord (without illustration)</b>			
	24	16	<b>5010410</b>	50
	<b>Angiodyn® Camera Cover (without illustration)</b>			
	250	13	<b>5012543</b>	25

# Intradyn® Arterial

ARTERIAL INTRODUCER, GUIDE WIRE, PUNCTURE NEEDLE

Intradyn® Arterial	Code-Number	Sales Unit (pcs.)
--------------------	-------------	-------------------

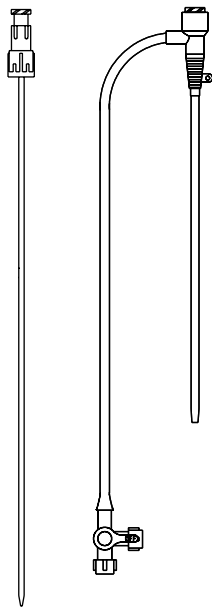

Introducer using the Seldinger technique according to Desilets Hofmann.

- **Guide Wire 40 cm**
  - Made of stainless steel,  $\varnothing$  0.035" / 0.89 mm
  - Flexible J3-tip with insertion tool or flexible straight tip
- **Vessel Dilator 160 mm made of PE**
  - Flexible, minimal trauma to vessels
  - Smoothly tapered transition to guide wire
- **Sheath 110 mm made of FEP**
  - Thin-walled
  - Smoothly tapered transition to vessel dilator
  - Luer Lock connection
- **Hemostasis Valve**
  - To prevent retrograde blood flow
  - For arterial and venous application
  - Smoothly tapered transition for easy introduction of catheter
  - Sideport with three-way stopcock for easy administration of I.V. solutions and injection of medications

### Intradyn® Arterial (without guide wire)

F 5 grey	<b>5210763</b>	20
F 6 green	<b>5210771</b>	20
F 7 orange	<b>5210780</b>	20

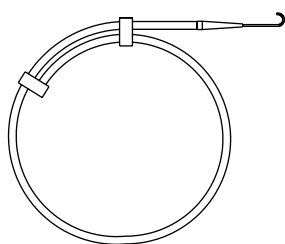

### Intradyn® Arterial (with J3-guide wire)

F 4 red	<b>5210033</b>	20
F 5 grey	<b>5210704</b>	20
F 6 green	<b>5210712</b>	20
F 7 orange	<b>5210720</b>	20

### Intradyn® Arterial Guide Wire

- With J3-tip and straightener
- 40 cm long, 0.035"
- In dispenser

J3 SFU-40-035	<b>5050529</b>	25
---------------	----------------	----



### Intradyn® Arterial Puncture Needle (Seldinger)

- Smoothly tapered design for introduction of the guide wire up to max.  $\varnothing$  0.035" (0.089 mm)
- Luer Lock-fitting

Gauge (G)	Diameter (mm)	Length (mm)	Color	Code-Number	Sales Unit (pcs.)
18	1.3	70	Light pink	<b>5208505</b>	50

# Intradyn® Tear-Away

## TEAR-AWAY INTRODUCER

### Intradyn® Tear-Away

Code-  
Number

Sales Unit  
(pcs.)

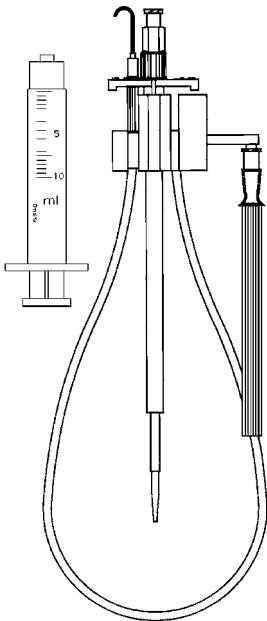

Tear-Away introducer sheath uses the Seldinger technique according to Desilets Hofmann.

- Pre-scored tearing line ensures clean and easy sheath removal after catheter placement
- Spin-lock connector holds dilatator and sheath together, preventing dilatator from backing out of sheath during vascular access

#### Intradyn® Tear-Away

- **Intradyn Puncture Needle According to Seldinger 1.3 x 70 mm (18 G)**
  - Made of stainless steel
  - Smoothly tapered hub transition for easy introduction of guide wire
- **Guide Wire 40 cm**
  - Made of stainless steel,  $\varnothing$  0.035" / 0.89 mm
  - Flexible J3-tip and flexible straight tip
- **Vessel Dilatator 190 mm made of PE**
  - Flexible, minimal trauma to vessels
  - Smoothly tapered transition to guide wire
- **Introducer sheath 160 mm made of FEP (thin-walled)**
  - Smoothly tapered transition to vessel dilatator
- **Syringe Luer Lock-fitting 10 ml**

#### Intradyn® Tear-Away Introducer

F 6	5210313	20
F 7	5210593	20
F 8	5210321	20
F 9	5210330	20
F 10	5210348	20
F 11	5210585	20

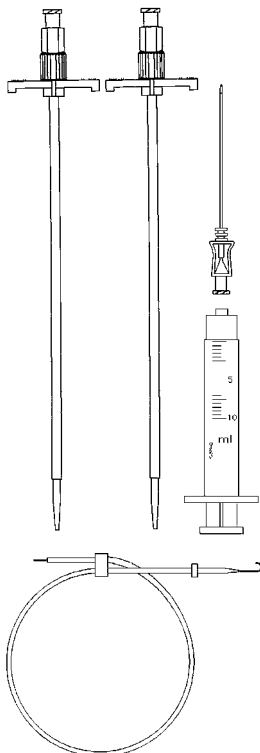

#### Intradyn® Dual Tear-Away Introducer

- Splittable introducer set with two sheaths for introduction of two probes for VDD- and DDD-pacemaker
- Same configuration as Intradyn Tear-Away, with two extra introducer sheaths and two dilatators

#### Intradyn® Dual Tear-Away Introducer

F 10	5212537	20
------	---------	----





**Distributor**

**B. Braun Melsungen AG | Vascular Systems | Sieversufer 8 | 12359 Berlin | Germany**  
**Phone +49 30 568207-300 | Fax +49 30 568207-210 | [www.bbraun.com](http://www.bbraun.com)**

Manufacturer acc. to MDD 93/42/EEC

B. Braun Melsungen AG | Carl-Braun-Str. 1 | 34212 Melsungen | Germany

**Exceptions:**

NSE Alpha is manufactured by Goodman Co. Ltd., Japan | Angiographic Catheters and Serpia are manufactured by PendraCare International B.V., The Netherlands

The product trademarks 'SeQuent', 'Coroflex', 'Intradyn' and 'Angiodyn' are registered trademarks of B. Braun Melsungen AG. NSE Alpha is a registered trademark of Goodman Co. Ltd., Japan. Serpia is a registered trademark of PendraCare International B.V., The Netherlands.

Subject to technical changes. All rights reserved. This brochure may only be used for the exclusive purpose of obtaining information about our products. Reproduction in any form partial or otherwise is not permitted.